



Turbo Liquidizers Turbo Liquidiser for Soups - 2 speeds (830 and 1660 rpm)

ITEM # _____

MODEL # _____

NAME # _____

SIS # _____

AIA # _____



603795 (DTBM150-02)

Turbo liquidizer,
removable mixer tube for
soups, 2 speed micro
liquidizer - 400V/3/50

Short Form Specification

Item No. _____

For mixing, liquidising, reducing and emulsifying. Constructed entirely in 18/8 stainless steel. Mounted on a mobile stainless steel trolley. Can be adapted to all recipient shapes: cylindrical, rectangular, etc. The mixer tube is easily removable without tools and can be dismantled in separate parts: tube, shaft, bearing, and rotor. No volt release system. Safety device in non-working position and protective ring for the grinding head. 2 speeds motor: 830 and 1660 rpm. Stainless steel micro liquidiser for fish soup available as an option. Supplied with stainless steel micro liquidiser for kitchen use.

Main Features

- Used to mix, blend and emulsify vegetable and soups, fruit and vegetable purées, liquid pastries, sauces and much more directly in cooking pots/containers.
- Liquidiser is mounted on a mobile stainless steel trolley and is height adjustable on installation.
- Mixer tube is easily removable without tools and can be dismantled in separate parts: tube, shaft, bearing and rotor.
- Turbine accelerates the flow of the liquid over the impeller providing a greater throughput and finer grinding.
- Safety device allows the machine to start only when it is in a working position.
- Equipped with protective ring to cover grinding head.
- Suggested for deep and low pans containing between 500 and 1000 liter of liquid.
- Microliquidizer head easily removable and dishwasher safe.
- Remove the micro liquidisers and clean them separately under running water or in a dishwasher.

Construction

- Constructed entirely in stainless steel to offer maximum durability.
- 2 speeds: 830 and 1660 rpm.
- Power: 4500 W.
- IP55 electrical controls and IP34 overall machine.

Included Accessories

- 1 of Stainless steel micro liquidiser for TBM150 (kitchen) PNC 653243

Optional Accessories

- Stainless steel micro liquidiser for TBM150 (fish soup) PNC 650043
- Stainless steel micro liquidiser for TBM150 (kitchen) PNC 653243

APPROVAL: _____



Turbo Liquidizers Turbo Liquidiser for Soups - 2 speeds (830 and 1660 rpm)

Front

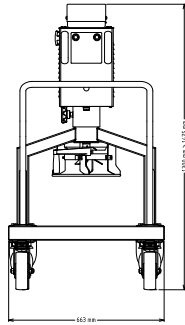

Side

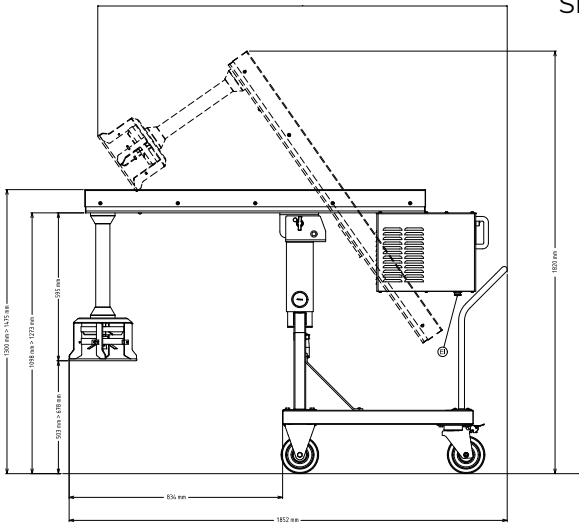

EI = Electrical inlet
(power)

Top

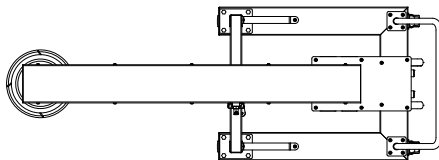

Electric

Supply voltage:

603795 (DTBM150-02) 380-415 V/3 ph/50 Hz

Electrical power max.:

4.5 kW

Total Watts:

4.5 kW

Capacity:

Capacity (up to):

1000 litres

Key Information:

External dimensions,

Width:

663 mm

External dimensions,
Depth:

1852 mm

External dimensions,
Height:

1475 mm

Shipping weight:

220 kg



Turbo Liquidizers
Turbo Liquidiser for Soups - 2 speeds (830 and 1660 rpm)
The company reserves the right to make modifications to the products
without prior notice. All information correct at time of printing.

2024.04.24